

# ***DUKANE***

## **Portable LCD Projector Model 8781**



## **USER'S MANUAL**

#080006

# Projector 8781 User's Manual (concise)

Thank you for purchasing this projector.

**⚠ WARNING** ▶ Before using this product, be sure to read all manuals for this product. See “Using the CD manual” (📖15) to read the manuals in the CD. After reading them, store them in a safe place for future reference.

## Contents

Contents of package..... 1	Adjusting the projector's elevator ..... 8
Preparations ..... 2	Displaying the picture ..... 9
Fastening the lens cover..... 2	Turning off the power..... 10
Loading batteries into the remote control..... 2	Replacing the lamp..... 11
Arrangement..... 3	Cleaning and replacing the air filter.. 13
Connecting your devices ..... 4	Replacing the internal clock battery.. 14
Using a USB storage ..... 6	Using the CD manual ..... 15
Using an SD card..... 6	Regulatory notices..... 16
Connecting power supply ..... 7	Specifications ..... 18
Turning on the power..... 7	Warranty and after-service ..... 19

## Contents of package

Your projector should come with the items shown below. Check that all the items are included. Contact to your dealer immediately if any items are missing.

- (1) Remote control with two AA batteries
- (2) Power cord
- (3) RGB cable
- (4) Audio/Video cable
- (5) Lens cover and Strap  
    Lens cover is attached to the projector.
- (6) User's manuals (Book x1, CD x1)
- (7) Soft case
- (8) Security label
- (9) Wireless network card (SD card)
- (10) Slot cover lock
- (11) Application CD

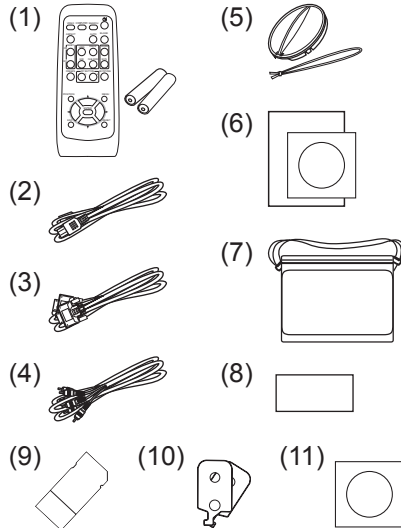

**NOTE** • Keep the original packing materials for future reshipment. Be sure to use the original packing materials when moving the projector. Use special caution for the lens.

## Preparations

### Fastening the lens cover

To avoid losing the lens cover, please fasten the lens cover to the projector using the enclosed strap.

1. Fix the strap to the strap hole of the lens cover.
  - Thread one end of the strap through the strap hole of the lens cover and make the loop at the end, and let the other end of the strap through the loop. Not have a knot in the strap at either end.
2. Fix the strap to the strap hole of the projector. Thread the other end of the strap through the strap hole of the projector and make the loop there. Let the lens cover with the one end of strap through the loop.

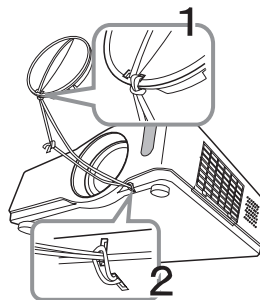

### Loading batteries into the remote control

Please set the batteries to the remote control before using it. If the remote control starts to malfunction, try to replace the batteries. If you will not use the remote control for long period, remove the batteries from the remote control and store them in a safe place.

1. Holding the hook part of the battery cover, remove it.
2. Align and insert the two AA batteries (HITACHI MAXELL, Part No.LR6 or R6P) according to their plus and minus terminals as indicated in the remote control.
3. Replace the battery cover in the direction of the arrow and snap it back into place.

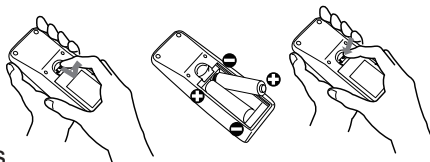

**⚠ WARNING** ► Always handle the batteries with care and use them only as directed. Improper use may result in battery explosion, cracking or leakage, which could result in fire, injury and/or pollution of the surrounding environment.

- Be sure to use only the batteries specified. Do not use batteries of different types at the same time. Do not mix a new battery with used one.
- Make sure the plus and minus terminals are correctly aligned when loading a battery.
- Keep a battery away from children and pets.
- Do not recharge, short circuit, solder or disassemble a battery.
- Do not allow a battery in a fire or water. Keep batteries in a dark, cool and dry place.
- If you observe battery leakage, wipe out the leakage and then replace a battery. If the leakage adheres to your body or clothes, rinse well with water immediately.
- Obey the local laws on disposing the battery.

## Arrangement

Refer to the illustrations and tables below to determine screen size and projection distance.

The values shown in the table are calculated for a full size screen: 1024×768

- Ⓐ Screen size (diagonal)
- Ⓑ Projection distance (±10%)
- Ⓒ<sub>1</sub>, Ⓒ<sub>2</sub> Screen height (±10%)

### On a horizontal surface

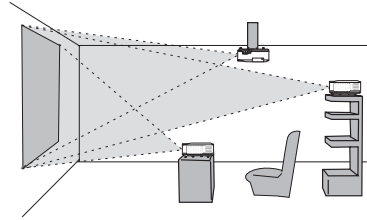
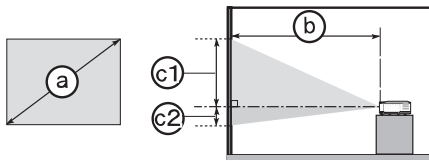

### Suspended from the ceiling

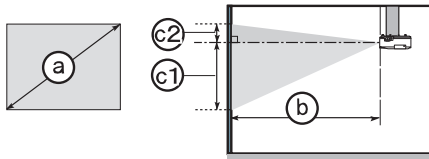

- Keep a space of 30 cm or more between the sides of the projector and other objects such as walls.
- Consult with your dealer before a special installation such as suspending from a ceiling.

Ⓐ Screen size (diagonal)		4 : 3 screen								16 : 9 screen							
		Ⓑ Projection distance				Ⓒ <sub>1</sub> Screen height		Ⓒ <sub>2</sub> Screen height		Ⓑ Projection distance				Ⓒ <sub>1</sub> Screen height		Ⓒ <sub>2</sub> Screen height	
		min.		max.						min.		max.					
inch	m	m	inch	m	inch	cm	inch	cm	inch	m	inch	m	inch	cm	inch	cm	inch
30	0.8	0.9	35	1.1	43	41	16	5	2	1.0	39	1.2	47	39	15	-1	0
40	1.0	1.2	47	1.4	57	55	22	6	2	1.3	52	1.6	62	51	20	-2	-1
50	1.3	1.5	59	1.8	71	69	27	8	3	1.6	65	2.0	78	64	25	-2	-1
60	1.5	1.8	71	2.2	86	82	32	9	4	2.0	78	2.4	94	77	30	-2	-1
70	1.8	2.1	83	2.5	100	96	38	11	4	2.3	91	2.8	109	90	35	-3	-1
80	2.0	2.4	95	2.9	115	110	43	12	5	2.6	104	3.2	125	103	41	-3	-1
90	2.3	2.7	107	3.3	129	123	49	14	5	3.0	117	3.6	141	116	46	-4	-1
100	2.5	3.0	119	3.6	144	137	54	15	6	3.3	130	4.0	156	129	51	-4	-2
120	3.0	3.6	143	4.4	172	165	65	18	7	4.0	156	4.8	188	154	61	-5	-2
150	3.8	4.6	179	5.5	216	206	81	23	9	4.9	195	6.0	235	193	76	-6	-2
200	5.1	6.1	239	7.3	288	274	108	30	12	6.6	261	8.0	314	257	101	-8	-3
250	6.4	7.6	299	9.1	360	343	135	38	15	8.3	326	10.0	392	322	127	-10	-4
300	7.6	9.1	359	11.0	432	411	162	46	18	9.9	391	12.0	471	386	152	-12	-5

- ⚠ WARNING** ▶ Install the projector in a stable horizontal position.  
▶ Place the projector in a cool place, and ensure that there is sufficient ventilation.  
▶ Do not place the projector anywhere where it may get wet.
- ⚠ CAUTION** ▶ Avoid placing the projector in smoky, humid or dusty place.  
▶ Position the projector to prevent light from directly hitting the projector's remote sensor.

## Connecting your devices

Be sure to read the manuals for devices before connecting them to the projector. Make sure that all the devices are suitable to be connected with this product, and prepare the cables required to connect. Please refer to the following illustrations to connect them.

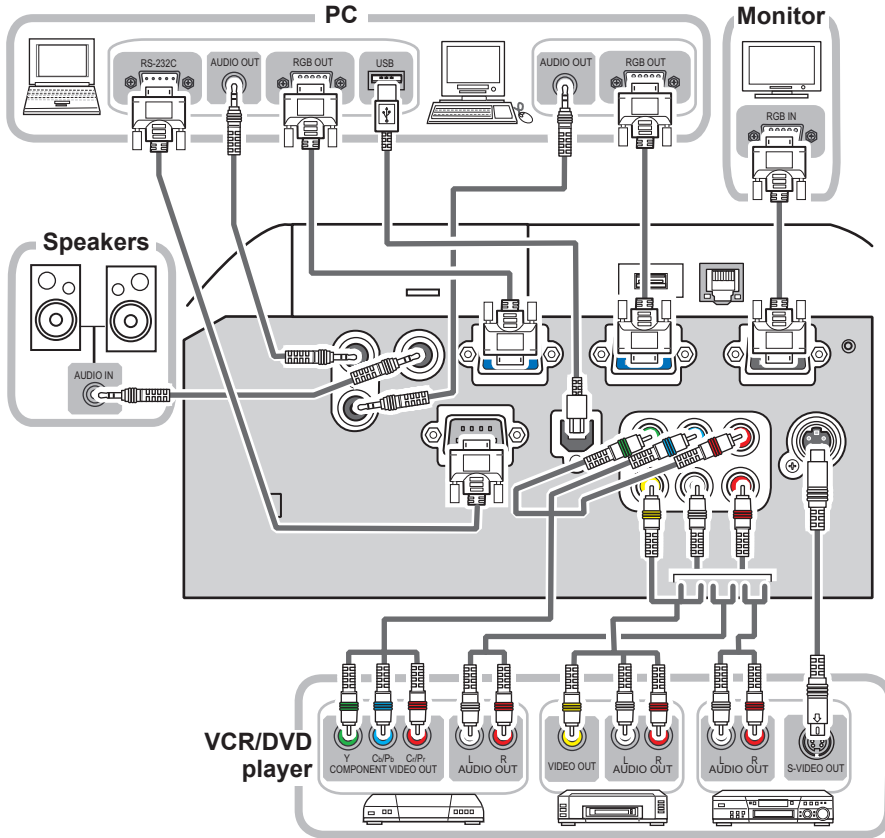

(continued on next page)

## Connecting your devices (continued)

To use MIU (Multi Information processing Unit) function, please connect at least one of the devices drawn in the following illustration to the projector.

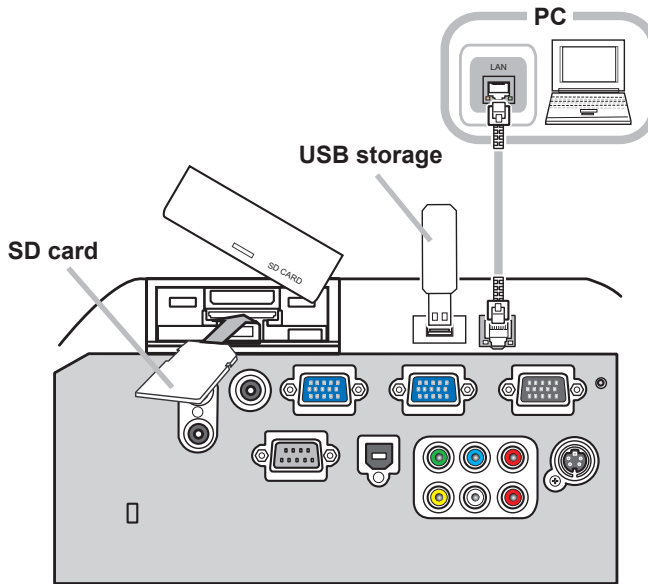

- ⚠ **WARNING** ▶ Do not disassemble or modify the projector and accessories.
- ▶ Be careful not to damage the cables, and do not use damaged cables.
- ⚠ **CAUTION** ▶ Turn off all devices and unplug their power cords prior to connecting them to projector. Connecting a live device to the projector may generate extremely loud noises or other abnormalities that may result in malfunction or damage to the device and the projector.
- ▶ Use appropriate accessory or designated cables. Ask your dealer about non-accessory cables which may be required a specific length or a ferrite core by the regulations. For cables with a core only at one end, connect the end with the core to the projector.
- ▶ Make sure that devices are connected to the correct ports. An incorrect connection may result in malfunction or damage to the device and the projector.

(continued on next page)

## Connecting your devices (continued)

### Using a USB storage

In order to view images stored in a USB storage, such as a USB memory, insert the device into the USB STORAGE slot.

Before removing the USB storage, be sure to perform the REMOVE MEDIA procedure using the PC-LESS PRESENTATION menu under the MIU menu.

### Using an SD card

In order to view images stored in an SD storage, such as an SD memory card, insert the device into the SD card slot. Or, in order to use the wireless network function, load the internal clock battery (🔋 14) and insert the designated wireless network card into the SD card slot.

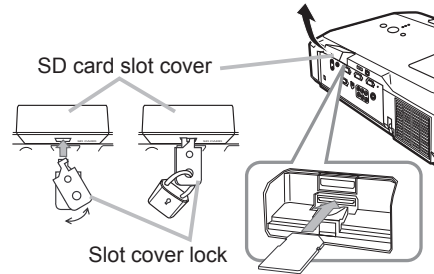

#### Inserting the SD card

1. Make sure that the power code is not plugged into the projector for the wireless network card only.
2. Remove the SD card slot cover. To remove it, it might be recommended to hook the edge of its side face upward.
3. Slowly insert the SD card completely into the SD card slot. Make sure that the angled corner of the SD card is placed into the right side of the SD card slot, while inserting.
4. Replace the SD card slot cover. It is recommended that the cover is slid sideways to the projector.

#### Using the slot cover lock for security

Using the enclosed slot cover lock can prevent the SD card slot cover from being opened.

1. Open the two plates of the slot cover lock to put the tips of two plates together, and then insert the tips to the lock hole of the SD card slot cover.
2. Put the body of the two plates together. Then, hook a padlock or combination lock to the hole of the slot cover lock.

#### Removing the SD card

1. Perform the REMOVE MEDIA procedure using the PC-LESS PRESENTATION menu under the MIU menu for SD Storage card only.
2. Turn the projector off and unplug the power code from the projector for the wireless network card only.
3. Remove the SD card slot cover. After taking the SD card away, replace the SD card slot cover.

**⚠ WARNING** ▶ Do not disassemble or modify the projector and accessories.

▶ Do not touch the SD card while being accessed.

**⚠ CAUTION** ▶ The designated wireless network card is required to use the wireless network function of this projector.

▶ The wireless network card is not permitted to be sold or used in some countries and regions. Use the card only in the country or region where you buy it. For more information, contact to your dealer.

**NOTE** • When using the projector with a wired LAN, please remove the wireless network card.

## Connecting power supply

1. Put the connector of the power cord into the AC inlet of the projector.
2. Firmly plug the power cord's plug into the outlet.

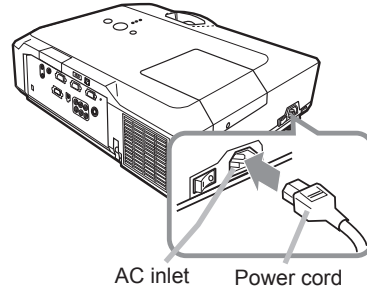

ENGLISH

**⚠ WARNING** ▶ Please use extra caution when connecting the power cord, as incorrect or faulty connections may result in fire and/or electrical shock.

- Only use the power cord that came with the projector. If it is damaged, contact to your dealer to newly get correct one.
- Only plug the power cord into an outlet whose voltage is matched to the power cord. The power outlet should be close to the projector and easily accessible. Remove the power cord for complete separation.
- Never modify the power cord.

## Turning on the power

1. Make sure that the power cord is firmly and correctly connected to the projector and the outlet.
2. Remove the lens cover, and set the power switch to the ON position (marked "I").
3. Press the STANDBY/ON button on the projector or the remote control.

The projection lamp will light up and the POWER indicator will begin blinking in green. When the power is completely on, the indicator will stop blinking and light in steady green.

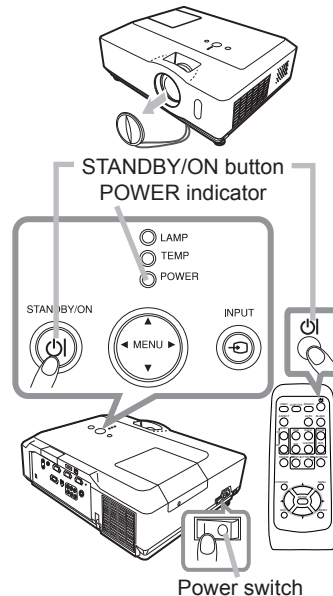

**⚠ WARNING** ▶ A strong light is emitted when the projector's power is on. Do not look into the lens of the projector or look inside of the projector through any of the projector's openings.

**NOTE** • Please power on the projector prior to the connected devices.

- When the AUTO ON of the OPTION menu is set to the TURN ON, and the power was turned off by the power switch last time, turning the power switch on makes the projection lamp light on without pushing the STANDBY/ON button. For more information, please see the "Operating Guide" in the CD.



## Adjusting the projector's elevator

When the place to put the projector is slightly uneven to the left or right, use the elevator feet to place the projector horizontally.

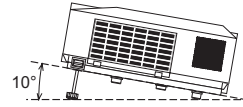

Using the feet can also tilt the projector in order to project at a suitable angle to the screen, elevating the front side of the projector within 10 degrees.

This projector has 2 elevator feet and 2 elevator buttons. An elevator foot is adjustable while pushing the elevator button on the same side as it.

1. Holding the projector, push the elevator buttons to loose the elevator feet.
2. Position the front side of the projector to the desired height.
3. Release the elevator buttons in order to lock the elevator feet.
4. After making sure that the elevator feet are locked, put the projector gently.
5. If necessary, the elevator feet can be manually twisted to make more precise adjustments. Hold the projector when twisting the feet.

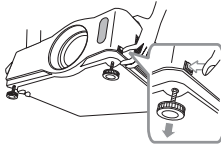

To loose an elevator foot, push the elevator button on the same side as it.

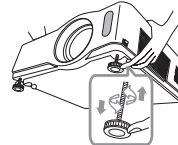

To finely adjust, twist the foot.

**⚠ CAUTION** ► Do not handle the elevator buttons without holding the projector, since the projector may drop down.  
► Do not tilt the projector other than elevating its front within 10 degrees using the adjuster feet. A tilt of the projector exceeding the restriction could cause malfunction or shortening the lifetime of consumables, or the projector itself.

## Displaying the picture

1. Activate your signal source. Turn the signal source on, and make it send the signal to the projector.
2. To adjust volume, use the ▲/▼ cursor buttons after pressing the VOLUME button on the remote control.  
To have the projector silent, press the MUTE button on the remote control.
3. Press the INPUT button on the projector.  
Each time you press the button, the projector switches its input port in turn. You can also use the remote control to select an input signal. Press the VIDEO button for selecting an input signal from the COMPONENT (Y, Cb/Pb, Cr/Pr), VIDEO or S-VIDEO port, or the COMPUTER button for selecting an input signal from the COMPUTER IN1, COMPUTER IN2 or MIU.
4. Press the ASPECT button on the remote control. Each time you press the button, the projector switches the mode for aspect ratio in turn.
5. Use the zoom ring to adjust the screen size.
6. Use the focus ring to focus the picture.

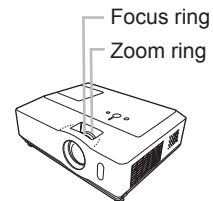
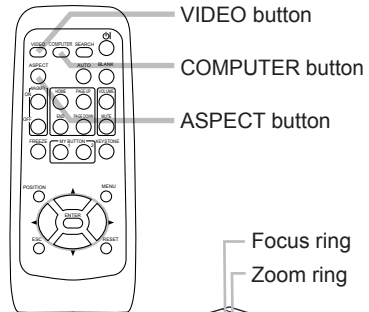
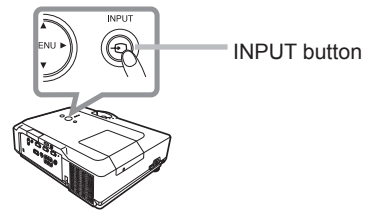
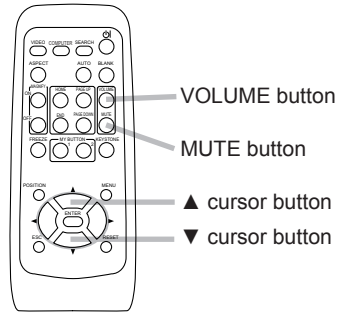

**NOTE** • The ASPECT button does not work when no proper signal is inputted.  
• For the details of how to adjust the picture, please see the “Operating Guide” in the CD.

## Turning off the power

1. Press the STANDBY/ON button on the projector or the remote control.  
The message "Power off?" will appear on the screen for about 5 seconds.
2. Press the STANDBY/ON button again while the message appears.  
The projector lamp will go off, and the POWER indicator will begin blinking in orange. Then the POWER indicator will stop blinking and light in steady orange when the lamp cooling is complete.
3. Make sure that the POWER indicator lights in steady orange, and set the power switch to the OFF position (marked "O"). Attach the lens cover.  
Do not turn the projector on for about 10 minutes or more after turning it off. Turning the projector on again too soon could shorten the lifetime of some consumable parts of the projector.

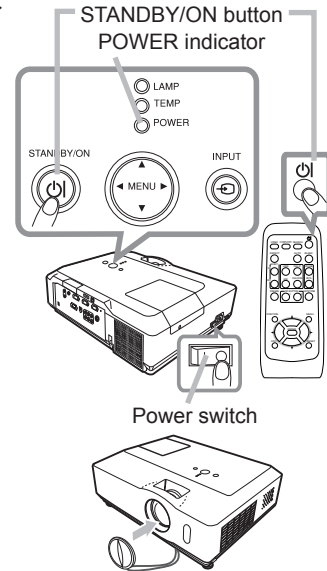

**⚠ WARNING** ► Do not touch around the lamp cover and the exhaust vents during use or just after use, since it is too hot.  
► Remove the power cord for complete separation. The power outlet should be close to the projector and easily accessible.

**NOTE** • Please power off the projector after any connected devices are powered off.  
• This projector has the AUTO OFF function that can make the projector turn off automatically. For more information, please see the "Operating Guide" in the CD.

## Replacing the lamp

A lamp has finite product life. Using the lamp for long periods of time could cause the pictures darker or the color tone poor. Note that each lamp has a different lifetime, and some may burst or burn out soon after you start using them.

Preparation of a new lamp and early replacement are recommended. To prepare a new lamp, contact to your dealer and tell the lamp type number.

**Type number : 456-8755G**

1. Turn the projector off, and unplug the power cord.  
Allow the projector to cool for at least 45 minutes.
2. Prepare a new lamp. If the projector is mounted on a ceiling, or if the lamp has broken, also ask the dealer to replace the lamp.

In case of replacement by yourself, follow the following procedure.

3. Loosen the screw (marked by arrow) of the lamp cover and then slide the lamp cover to the side to remove it.
4. Loosen the 2 screws (marked by arrow) of the lamp, and slowly pick up the lamp by the handles.
5. Insert the new lamp, and retighten firmly the 2 screws of the lamp that are loosened in the previous process to lock it in place.
6. Slide the lamp cover back in place and firmly fasten the screw of the lamp cover.
7. Turn the projector on and reset the lamp time using the LAMP TIME item in the OPTION menu.
  - (1) Press the MENU button to display a menu.
  - (2) Point at the Go to Advanced Menu ... in the menu using the ▼/▲ button, then press the ► button.
  - (3) Point at the OPTION in the left column of the menu using the ▼/▲ button, then press the ► button.
  - (4) Point at the LAMP TIME using the ▼/▲ button, then press the ► button. A dialog will appear.
  - (5) Press the ▲ button to select RESET on the dialog. It performs resetting the lamp time.

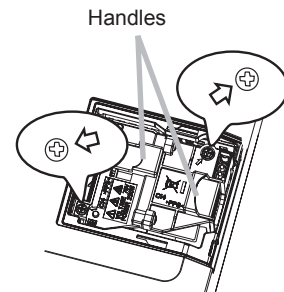
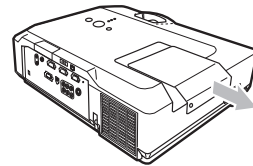
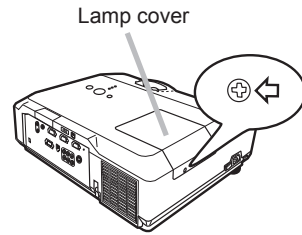

**⚠ CAUTION** ► Do not touch any inner space of the projector, while the lamp is taken out.

**NOTE** • Please reset the lamp time only when you have replaced the lamp, for a suitable indication about the lamp.

**⚡ HIGH VOLTAGE    ⚠ HIGH TEMPERATURE    ⚠ HIGH PRESSURE**

**⚠ WARNING** ► The projector uses a high-pressure mercury glass lamp. The lamp can break with a loud bang, or burn out, if jolted or scratched, handled while hot, or worn over time. Note that each lamp has a different lifetime, and some may burst or burn out soon after you start using them. In addition, when the bulb bursts, it is possible for shards of glass to fly into the lamp housing, and for gas containing mercury to escape from the projector's vent holes.

► **About disposal of a lamp:** This product contains a mercury lamp; do not put it in a trash. Dispose of it in accordance with environmental laws.

- For lamp recycling, go to [www.lamprecycle.org](http://www.lamprecycle.org) (in the US).
- For product disposal, contact your local government agency or [www.eiae.org](http://www.eiae.org) (in the US) or [www.epsc.ca](http://www.epsc.ca) (in Canada).

For more information, contact your dealer.

  
Disconnect the plug from the power outlet

- If the lamp should break (it will make a loud bang when it does), unplug the power cord from the outlet, and make sure to request a replacement lamp from your local dealer. Note that shards of glass could damage the projector's internals, or cause injury during handling, so please do not try to clean the projector or replace the lamp yourself.
- If the lamp should break (it will make a loud bang when it does), ventilate the room well, and make sure not to breathe the gas that comes out of the projector vents, or get it in your eyes or mouth.
- Before replacing the lamp, turn the projector off and unplug the power cord, then wait at least 45 minutes for the lamp to cool sufficiently. Handling the lamp while hot can cause burns, as well as damaging the lamp.



- Never unscrew except the appointed (marked by an arrow) screws.
- Do not open the lamp cover while the projector is suspended from a ceiling. This is dangerous, since if the lamp's bulb has broken, the shards will fall out when the cover is opened. In addition, working in high places is dangerous, so ask your local dealer to have the lamp replaced even if the bulb is not broken.
- Do not use the projector with the lamp cover removed. At the lamp replacing, make sure that the screws are screwed in firmly. Loose screws could result in damage or injury.



- Use only the lamp of the specified type.
- If the lamp breaks soon after the first time it is used, it is possible that there are electrical problems elsewhere besides the lamp. If this happens, contact to your local dealer or a service representative.
- Handle with care: jolting or scratching could cause the lamp bulb to burst during use.
- Using the lamp for long periods of time, could cause it dark, not to light up or to burst. When the pictures appear dark, or when the color tone is poor, please replace the lamp as soon as possible. Do not use old (used) lamps; this is a cause of breakage.

## Cleaning and replacing the air filter

Please check and clean the air filter periodically. When the indicators or a message prompts you to clean the air filter, comply with it as soon as possible. Replace the air filter when it is damaged or too soiled. To prepare a new air filter, contact to your dealer and tell the air filter type number.

**Type number : MU04951**

When you replace the lamp, please replace the air filter. An air filter of specified type will come together with a replacement lamp for this projector.

1. Turn the projector off, and unplug the power cord. Allow the projector to sufficiently cool down.
2. Use a vacuum cleaner on and around the filter cover.
3. Pull the filter cover knobs while lifting it. The filter unit which consists of the filter' cover, air filter and filter frame will come off.
4. Use a vacuum cleaner for the filter vent of the projector and the filter frame side of the filter unit. If the air filter is damaged or too soiled, replace it according to the following procedure number 5 to 7. Otherwise, please jump to the procedure number 8.
5. Pull the filter frame's knob up while holding the filter cover. The filter frame will come off and the air filter will appear.
6. Replace the air filter with new one.
7. Put the filter frame back.
8. Put the filter unit back into the projector.
9. Turn the projector on and reset the filter time using the FILTER TIME item in the EASY MENU.

- (1) Press the MENU button to display a menu.
- (2) Point at the FILTER TIME using the ▼/▲ button, then press the ► button. A dialog will appear.
- (3) Press the ▲ button to select RESET on the dialog. It performs resetting the filter time.

**⚠ WARNING ►** Before taking care of the air filter, make sure the power cable is not plugged in, then allow the projector to cool sufficiently.

► Use only the air filter of the specified type. Do not use the projector without the air filter or the filter cover. It could result in a fire or malfunction to the projector.

► Clean the air filter periodically. If the air filter becomes clogged by dust or the like, internal temperatures rise and could cause a fire, a burn or malfunction to the projector.

**NOTE** • Please reset the filter time only when you have cleaned or replaced the air filter, for a suitable indication about the air filter.

• The projector may display the message such as "CHECK THE AIR FLOW" or turn off the projector, to prevent the internal heat level rising.

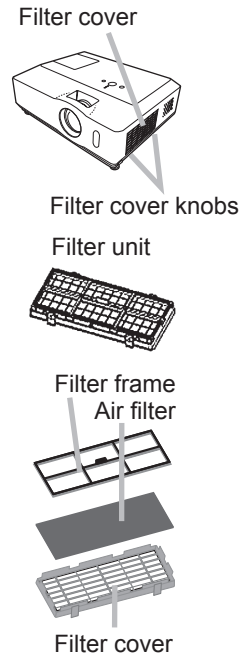

## Replacing the internal clock battery

Consumption of the battery makes the internal clock not to work correctly. When the internal clock is wrong or it has stopped, please replace the battery according to the following procedures.

1. Turn the projector off, and unplug the power cord. Allow the projector to cool sufficiently.
2. After making sure that the projector has cooled adequately, pull the SD card slot cover forward, pushing slightly its edge up, and remove it from the projector.
3. Remove the battery case.  
Hold the battery case gutter by finger nail or other thing and pull out the battery case slowly from the battery slot. While the projector is installed upside down, such as a ceiling mount, please remember the battery will drop down as soon as pulling the battery case out.
4. Take the old battery out from the battery case.
5. Replace a new battery.  
Replace battery with **HITACHI MAXELL, Part No.CR2032** only. Use of another battery may present a risk of fire or explosion.  
Put a new battery into battery case. Please make sure that the + is facing upward. Insert the battery case slowly into the battery slot until you hear the snap.
6. Close the slot cover. Replace the SD card slot cover by reversing the procedure used when removing the cover.

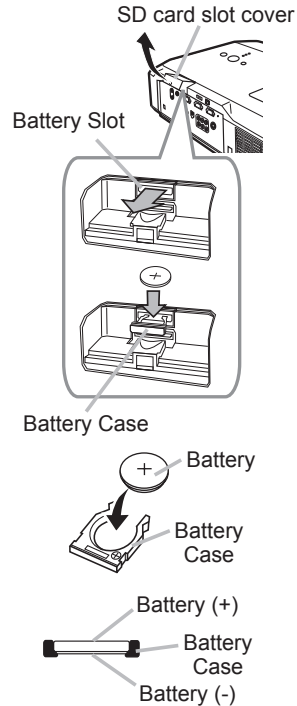

**⚠ WARNING** ► Always handle the batteries with care and use them only as directed. Battery may explode if mistreated. Do not recharge, disassemble or dispose of in fire.

And also improper use may result in cracking or leakage, which could result in fire, injury and/or pollution of the surrounding environment.

- Be sure to use only the batteries specified.
- Make sure the plus and minus terminals are correctly aligned when loading a battery.
- Keep a battery away from children and pets. If swallowed consult a physician immediately for emergency treatment.
- Do not short circuit or solder a battery.
- Do not allow a battery in a fire or water. Keep batteries in a dark, cool and dry place.
- If you observe battery leakage, wipe out the leakage and then replace a battery. If the leakage adheres to your body or clothes, rinse well with water immediately.
- Obey the local laws on disposing the battery.

**NOTE** • The internal clock's time will be reset when the battery is removed. Please reconfigure the time via the menu or a web browser after replacing the battery. (📖 **"Date/Time Settings" of the User's Manual - Network Guide**)

## Using the CD manual

The other manuals for this product are written into the included CD-ROM titled "User's Manual (detailed)". Before using the CD-ROM, please read the following to ensure the proper use.

### ■ System requirements

The system for using the CD-ROM requires the following.

<b>Windows®:</b>	OS:Microsoft® Windows® 98, 98SE, NT4.0, Me, 2000/XP, or later CPU:Pentium® processor 133MHz / Memory:32MB or more
<b>Macintosh®:</b>	OS:Mac OS 10.2 or later CPU:Power PC® / Memory:32MB or more
<b>CD-ROM drive:</b>	4x CD-ROM drive
<b>Display:</b>	256 color / 640x480 dots resolution
<b>Applications:</b>	Microsoft Internet Explorer4.0 and Adobe Acrobat Reader 4.0 or later

### ■ How to use the CD

1. Insert CD into PC's CD-ROM drive.

<b>Windows®:</b>	In a while, Web browser automatically starts. Start up window comes up.
<b>Macintosh®:</b>	(1) Double-click on the "Projectors" icon appeared on the desktop screen. (2) When "main.html" file is clicked, Web browser will start and Initial window will appear.

2. Click the model name of your projector first, and then click language you want from the displayed list. The User's manual (detailed) will open.

**⚠ CAUTION** ▶ Only use the CD-ROM in a computer CD drive. The CD-ROM is designed for PC use only. NEVER INSERT THE CD-ROM INTO A NON-COMPUTER CD PLAYER! Inserting the CD-ROM into an incompatible CD drive may produce a loud noise, which in turn MAY RESULT IN EAR AND SPEAKER DAMAGE!

- After using CD-ROM, please put it into CD case and keep it. Please keep the CD neither in direct sunlight nor in a high temperature and high humidity environment.

**NOTE** • The information in the CD-ROM is subject to change without notice.

- No responsibility is taken for any obstacle and defect to hardware and software of your PC as a result of the use of the CD-ROM.
- All or Any part of the information in the CD-ROM must not be copied, reproduced or republished without notice to our company.



## Regulatory notices

### Declaration of Conformity

Trade name	HITACHI
Model Number	CP-X308
Responsible Party	Hitachi America, Ltd.
Address	900 Hitachi way, Chula Vista, A 91914-3556 U.S.A.
Telephone Number	+1 -800-225-1741

This device complies with part 15 of the FCC Rules. Operation is subject to the following two conditions: (1) This device may not cause harmful interference, and (2) this device must accept any interference received, including interference that may cause undesired operation.

### FCC Statement warning

**WARNING:** This equipment has been tested and found to comply with the limits for a Class B digital device, pursuant to Part 15 of the FCC Rules. These limits are designed to provide reasonable protection against harmful interference in a residential installation. This equipment generates, uses, and can radiate radio frequency energy and, if not installed and used in accordance with the instructions, may cause harmful interference to radio communications. However, there is no guarantee that interference will not occur in a particular installation. If this equipment does cause harmful interference to radio or television reception, which can be determined by turning the equipment off and on, the user is encouraged to try to correct the interference by one or more of the following measures:

- Reorient or relocate the receiving antenna.
- Increase the separation between the equipment and receiver.
- Connect the equipment into an outlet on a circuit different from that to which the receiver is connected.
- Consult the dealer or an experienced radio/TV technician for help.

**INSTRUCTIONS TO USERS:** This equipment complies with the requirements of FCC (Federal Communication Commission) equipment provided that the following conditions are met. Some cables have to be used with the core set. Use the accessory cable or a designated-type cable for the connection. For cables that have a core only at one end, connect the core to the projector.

**CAUTION:** Changes or modifications not expressly approved by the party responsible for compliance could void the user's authority to operate the equipment.

### For the Customers in CANADA

**NOTICE:** This Class B digital apparatus complies with Canadian ICES-003.

(continued on next page)

## Regulatory notices (continued)

### Information for users applicable in European Union countries

1. The manufacturer (Gemtek) hereby declare that this equipment (wireless network card), model SD-Link11g is in compliance with the essential requirements and other relevant provisions of Directive 1999/5/EC.

CE 0560 !

ENGLISH



2. This symbol on the product or on its packaging means that your electrical and electronic equipment should be disposed at the end of life separately from your household wastes. There are separate collection systems for recycling in EU. For more information, please contact the local authority or the dealer where you purchased the product.

### FCC Important note

To comply with FCC RF exposure compliance requirements, the antenna used for this transmitter must be installed to provide a separation distance of at least 20 cm from all persons and must not be collocated or operating in conjunction with any other antenna or transmitter.

## Specifications

Item	Specifications	
Product name	Liquid crystal projector	
Liquid Crystal Panel	Panel size	1.6 cm (0.63 type)
	Drive system	TFT active matrix
	Pixels	786,432 pixels (1024 horizontal x 768 vertical)
Lens	Zoom lens F=1.7 ~ 1.9 f = 19.5~ 23.4 mm (approximately)	
Lamp	220W UHB	
Audio output	7 W	
Power supply	AC 100-120V/3.8A, AC220-240V/1.6A	
Power consumption	350W	
Temperature range	5 ~ 35°C (Operating)	
Size	340 (W) x 117 (H) x 270 (D) mm *Excluding protrusions Please refer to the following figure.	
Weight (mass)	approx. 4.0 kg	
Ports	<p><b>Computer input port</b>            COMPUTER IN1 .....D-sub 15 pin mini x1            .....D-sub 15 pin mini x1            COMPUTER IN2 .....D-sub 15 pin mini x1            .....D-sub 15 pin mini x1</p> <p><b>Computer output port</b>            MONITOR OUT .....D-sub 15 pin mini x1</p> <p><b>Video input port</b>            COMPONENT (Y, Cb/Pb, Cr/Pr) ..... RCA x3            S-VIDEO ..... mini DIN 4 pin x1            VIDEO ..... RCA x1</p> <p><b>Audio input/output port</b>            AUDIO IN1 ..... Stereo mini x1            AUDIO IN2 ..... Stereo mini x1            AUDIO IN3 ..... RCA x2            AUDIO OUT ..... Stereo mini x1</p> <p><b>Others</b>            USB STORAGE ..... USB-A x1            SD card ..... SD card slot x1            USB ..... USB-B x1            CONTROL ..... D-sub 9 pin x1            LAN ..... RJ45 x1</p>	
Optional parts	<p><b>Lamp:</b> 456-8755G  <b>Air filter:</b> MU04951  <b>Wireless network card:</b> VA08331</p> <p>*For more information, contact to your dealer.</p>	

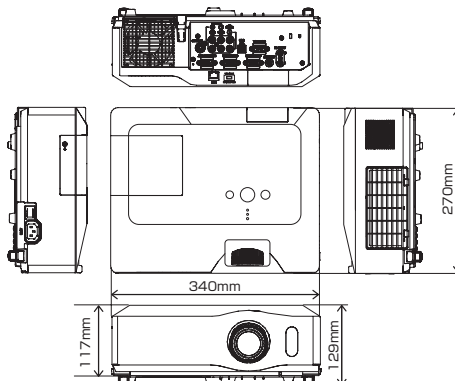

## Warranty and after-service

If an abnormal operation (such as smoke, strange odor or excessive sound) should occur, stop using the projector immediately. Otherwise if a problem occurs with the projector, first refer to the “Troubleshooting” of the “Operating Guide” in the CD and run through the suggested checks.

If this does not resolve the problem, please contact to your dealer or service company. They will tell you what warranty condition is applied.

Please check the following web address where you may find the latest information for this projector.

ENGLISH

# DUKANE

2900 Dukane Drive  
St. Charles, IL 60174  
[www.dukcorp.com/av](http://www.dukcorp.com/av)  
Service Dept: 800-676-2487  
Fax: 630-584-5156  
email: [avsales@dukcorp.com](mailto:avsales@dukcorp.com)

**NOTE** • The information in this manual is subject to change without notice.  
• The manufacturer assumes no responsibility for any errors that may appear in this manual.  
• The reproduction, transfer or copy of all or any part of this document is not permitted without express written consent.

### **Trademark acknowledgment**

- Mac, Macintosh, Power PC and Mac OS are registered trademarks of Apple Computer, Inc.
  - Pentium is a registered trademark of Intel Corporation.
  - Adobe and Acrobat are registered trademarks of Adobe Systems Incorporated.
  - Windows is a registered trademark of Microsoft Corporation.
  - VESA and SVGA are trademarks of the Video Electronics Standard Association.
- All other trademarks are the properties of their respective owners.

